

Article number: 46914513

Description: Torque limiter Safeguard A 45 L

Measures

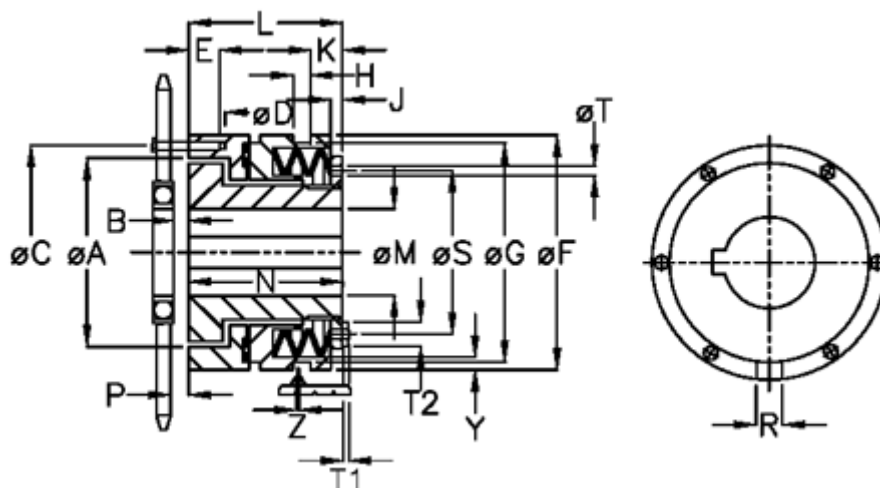

A	= 91.0	G	= 112.0	P	= 4.0
B	= 5.0	H	= 10	R	= 10
C	= 105	J	= 9.0	S	= 82
D	= 6xM8	K	= 20.0	T	= 6
Disc spring mounting	= 5x1L	L	= 78.0	T1	= 4.0
Disc spring version	= L - heavy	M max	= 45	T2	= 10
E	= 12.0	M min	= 18	Y	= 2
F	= 120	N	= 72.0	Z	= 0.0